

Information on Applications

Tolerance Manual

2nd Edition 2020

Issued by:

Glas Trösch GmbH, SANCO Beratung
Reuthebogen 7-9, D-86720 Nördlingen

© copyright 2020

Glas Trösch GmbH, SANCO Beratung

Applicable to print and electronic media, in whole and
in part. Not to be published without express consent.

This also applies to foreign languages.

Editorial: SANCO Tolerance Manual working group: Piotr
Cichecki, Bruno Geiger, Martin Fink, Hannah Gietzen,
Antonio Gioello, Markus Leuchtle, Rainer Leuchtle and
Joachim Wilke

Layout, technical illustration, setting and production:
TA Werbeagentur GmbH, Filderstadt

The technical data listed here conforms to the current
values at the time of going to print and can alter with-
out prior notice. The technical values are based on
the suppliers' information or were ascertained in the
course of tests by an independent testing institution in
accordance with the respectively valid standards. The
function values are based only on test specimens in the
dimensions provided for testing. No further guarantee
for technical values shall be accepted, in particular if
tests are performed in other installation situations or if
subsequent measurements are obtained in the building.
During installation, the current version of the SANCO
glazing guidelines must be followed without fail.
Legal claims cannot be derived from the content of
this book.

Date 02/2022

SANCO is a trademark

Contents

1. Preface / SANCO.....	1
2. External dimensions	2
3. Processing	3
4. Visual assessment	4
5. Assessment of sash bars inside the cavity	5
6. Screen printing, digital printing, enamel	6
7. Keyword index/definition.....	7



PREFACE

The SANCO Group

Even in the 1960s, it was clear to the far-sighted that the research, quality control and advertising work necessary to develop the product insulating glass could only be handled by a group. In 1969 the SANCO Group was founded in Germany, and quickly came to dominate the market. In 1984 the trademark rights were taken over by Glas Trösch from Switzerland. Insulating glass, laminated safety glass and toughened safety glass is produced by companies usually of small or medium size.

Consistent quality management is key to the success of the brand and of SANCO products. The ambition: making the best possible product for the client. In addition to in-house monitoring, external checks too are conducted by accredited European test institutes.

SANCO uses its Product Pass. It contains a list of the inspected insulating glass systems, verified rules as per DIN EN 1279-1: 2018-10 on replacing components in the insulating glass system, and the proven performance features as per DIN EN 1279-5: 2018-10. At the same time, it documents that the verifications for the CE mark can be used by the SANCO companies.



SANCO Tolerance Manual

The SANCO Tolerance Manual provides information on standards and rules relating to the tolerances of basic glass types, processed and refined products (toughened safety glass, heat strengthened glass, laminated safety glass, multi-pane insulated glass).

The SANCO Tolerance Manual can be an integral part of the general terms and conditions of the SANCO companies. References to other publications are indicated at the appropriate places. The quotations are those applying when the SANCO Tolerance Manual went to press.

The SANCO Tolerance Manual is based on the currently valid DIN / EN standards and on recognised guidelines. If there have been any changes since going to print, they shall take precedence. Tolerances not governed by standards, and additionally referenced in this manual, represent SANCO's in-house guidelines. Tolerances diverging from them must be clarified prior to order placement and confirmed in writing.

The SANCO Tolerance Manual is, as Information on Applications, part of SANCO's glazing guidelines in their currently valid version.

Note: DIN standards are not recognised in all countries. EN standards are valid throughout Europe. National regulations that may diverge must be complied with.



EXTERNAL DIMENSIONS

2.1 Thickness tolerances

2.1.1 Glass thickness tolerances for soda lime silicate glass as per DIN EN 572-8:2012+A1: 2016; for TSG as per DIN EN 12150-1:2015-12, DIN EN 14179-1:2016-12, DIN EN 1863-1:2012-02

Nominal thickness (mm)	Float glass, TSG, HSG	Ornamental glass, TSG made of ornamental glass,	Wired glass, wired ornamental glass
≤ 6 mm	± 0.2 mm	± 0.5 mm	± 0.6 mm
7 mm	± 0.3 mm		± 0.7 mm
8 mm	± 0.3 mm	± 0.8 mm	± 0.8 mm
9 mm			- 1.0 /+ 1.5 mm
10 mm	± 0.3 mm	± 1.0 mm	
12 mm	± 0.3 mm	± 1.5 mm	
≤ 15 mm	± 0.5 mm	± 1.5 mm	
> 15 mm	± 1.0 mm	± 2.0 mm	



Note: The SANCO Tolerance Manual is based on the currently valid DIN/EN standards and on recognised guidelines. If there have been any changes since going to print, they shall take precedence.

2.1.2 Thickness tolerance for laminated glass

The thickness tolerance of laminated glass is obtained from the sum of thickness tolerances of the basic glass types used, plus the thickness tolerance of the intermediate layers. If the total thickness of the intermediate layer is ≤ 2 mm, an additional deviation limit of ± 0.1 mm applies. With additional film inlays, a deviation limit of ± 0.2 mm must be taken into account for intermediate layers of > 2 mm. Nominal thickness of standard PVB film: 0.38 and 0.76 mm. The nominal thicknesses of further films can diverge from this (e.g. sound protection films with 0.5 or 0.89 mm). For fire protection/

cast resin layer etc., other tolerances may be valid.

Example: A laminated glass made from two float glass sheets with a nominal thickness of 4 mm and an intermediate film layer of 0.76 mm: The deviation limit is for float glass with 4 mm nominal thickness ± 0.2 mm and the deviation limit for the intermediate film layer ± 0.1 mm. The result is a nominal thickness of 8.76 mm and a deviation limit of ± 0.5 mm. (The measured total thickness is, as per DIN EN ISO 12543-5:2011-12, measured in hundredths of a millimetre and rounded to a tenth of a millimetre.)

2.1.3 Thickness tolerances of multi-pane insulating glass as per DIN EN 1279-1:2018-10

The actual thickness must be measured at each corner and near the centre points of the edges between the outer glass surfaces of the unit. The measured values must be measured with an accuracy of 0.01 mm and rounded to

0.1 mm. The measured values of the thicknesses must not diverge from the nominal thickness specified by the manufacturer of the multi-pane insulated glass by more than the tolerances specified in the table.

Glazing	Sheet	MIG thickness tolerance
Double glazing	All sheets float glass	± 1.0 mm
	Min one sheet of LG, ornamental glass or tempered	± 1.5 mm
Triple glazing	All sheets float glass	± 1.4 mm
	Min one sheet of LG, ornamental glass or tempered	+ 2.8 mm/- 1.4 mm

If a glass component has a nominal thickness of more than 12 mm or, in the case of LG a nominal thickness above 20 mm, the manufacturer of the MIG should be consulted.

2.2 Determining dimensions and perpendicularity

With the required nominal dimensions for the width B and the height H, the sheet must be produced in a tolerance range that

- does not exceed the tolerance limit (B+t) and (H+t) starting from the nominal dimension
- does not fall short of the tolerance limit (B-t) and (H-t) starting from the nominal dimension.

The sides of the predetermined tolerance frame must run parallel to one another and have a common centre point.

t = absolute tolerance

2.2.1 deviation limits for dimensions of rectangular sheets

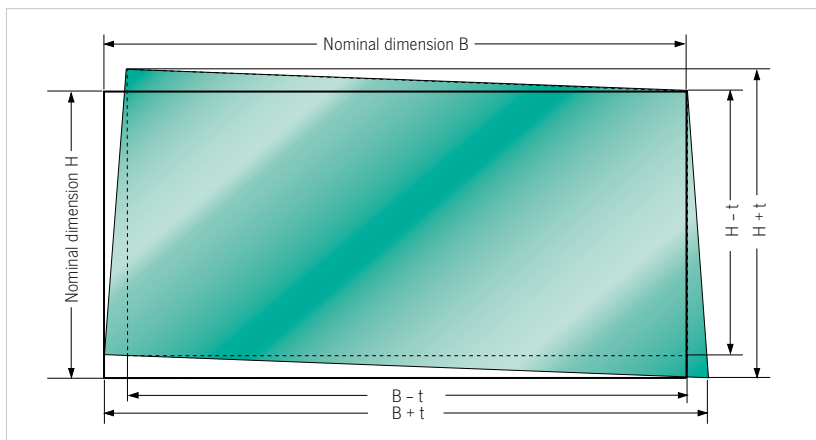

The fracturing of float glass can lead to a diagonal break.

The overbreak or underbreak (d) must be less than $1/4$ of the glass thickness (e) and within the permissible deviation limits (t).

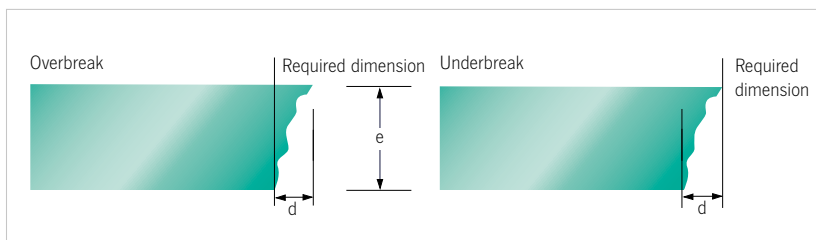

Production-related cut-back

With non-rectangular glass, it is often technically unavoidable that, particularly with narrow angles, the "glass tip" breaks off or has to be shortened by cutting it back.

Details must be clarified with the manufacturer in question.

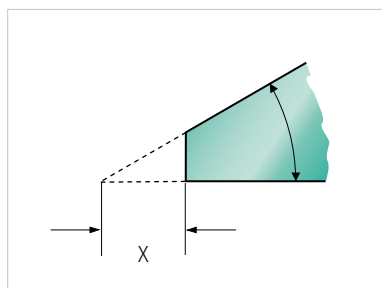

2.2.2 Deviation limit tolerances (t)

- for soda lime silicate glass as per DIN EN 572-8:2012+A1:2016
- for TSG as per DIN EN 12150-1:2015-12, DIN EN 14179-1:2016-12, DIN EN 1863-1:2012-02
- for LG and LSG as per DIN EN ISO 12543-5:2011-12¹
- for MIG as per DIN EN 1279-1:2018-10

Glass type/ nominal thickness	Deviation limit (t) of nominal dimensions in mm						
	(B, H) ≤ 1500	(B, H) ≤ 2000	(B, H) ≤ 3000	(B, H) > 3000	(B, H) ≤ 3500	(B, H) ≤ 5000	(B, H) > 5000
Float glass							
≤ 6 mm	± 1.0 mm		± 1.5 mm	± 2.0 mm			
≤ 12 mm	± 1.5 mm		± 2.0 mm	± 2.5 mm			
≤ 15 mm	± 2.0 mm		± 2.5 mm	± 3.0 mm			
> 15 mm	± 2.5 mm		± 3.0 mm	± 3.5 mm			
Ornamental glass							
≤ 6 mm	± 1.0 mm		± 1.5 mm	± 2.0 mm			
≤ 10 mm	± 1.5 mm		± 2.0 mm	± 2.5 mm			
> 10 mm	± 2.0 mm		± 2.5 mm	± 3.0 mm			
Wired glass, wired ornamental glass	± 1.5 mm		± 2.0 mm	± 2.5 mm			
TSG, h.g. TSG, HSG							
≤ 8 mm		± 2 mm	± 3 mm	± 4 mm			
> 8 mm		± 3 mm	± 4 mm	± 5 mm			
LG, LSG²							
≤ 8 mm total thickness		+3.0/-2.0	+4.5/-2.5	+5.0/-3.0			
> 8 mm							
each sheet < 10 mm		+3.5/-2.0	+5.0/-3.0	+6.0/-4.0			
min. 1 sheet ≥ 10 mm		+5.0/-3.5	+6.0/-4.0	+7.0/-5.0			
MIG³							
All sheets ≤ 6 mm		± 2.0 mm			± 3.0 mm	± 4.0 mm	± 5.0 mm
6 mm < thickest sheet ≤ 12 mm					± 3.0 mm	± 4.0 mm	± 5.0 mm
One sheet > 12 mm							± 5.0 mm

¹ This international standard does not apply for sheets with an area of less than 0.05 m².

² For LSG made of HSG, TSG, heat-soaked TSG, an additional tolerance of ± 3 mm applies.

³ Special dimensions and tolerances can be agreed.

The appropriate manufacturer must be consulted about tolerances for fire protection or cast resin layers.

2.3 Permissible diagonal differences (ν)

- for soda lime silicate glass as per DIN EN 572-8:2012+A1:2016
- for TSG as per DIN EN 12150-1:2015-12, DIN EN 14179-1:2016-12, DIN EN 1863-1:2012-02
- for LG and LSG as per DIN EN ISO 12543-5:2011-12¹

Glass type	Nominal thickness	Deviation limit (t) of nominal dimensions in mm			
		(B, H) ≤ 1500	(B, H) ≤ 2000	(B, H) ≤ 3000	(B, H) > 3000
Float glass	≤ 6 mm	≤ 3.0 mm		≤ 4.0 mm	≤ 5.0 mm
	≤ 12 mm	≤ 4.0 mm		≤ 5.0 mm	≤ 6.0 mm
	> 12 mm	≤ 5.0 mm		≤ 6.0 mm	≤ 8.0 mm
Ornamental glass	≤ 6 mm	≤ 3.0 mm		≤ 4.0 mm	≤ 5.0 mm
	≤ 12 mm	≤ 4.0 mm		≤ 5.0 mm	≤ 6.0 mm
	> 12 mm	≤ 5.0 mm		≤ 6.0 mm	≤ 8.0 mm
Wired glass, wired ornamental glass		≤ 3.0 mm		≤ 4.0 mm	≤ 5.0 mm
TSG, h.g. TSG, HSG	≤ 8 mm		≤ 4 mm	≤ 6 mm	≤ 8 mm
	> 8 mm		≤ 6 mm	≤ 8 mm	≤ 10 mm
LSG	Total thickness ≤ 8 mm		≤ 6 mm	≤ 8 mm	≤ 10 mm
	Total thickness > 8 mm each sheet < 10 mm		≤ 7 mm	≤ 9 mm	≤ 11 mm
	min. 1 sheet ≥ 10 mm		≤ 9 mm	≤ 11 mm	≤ 13 mm

2.4 Displacement tolerance

The individual sheets of an LG/LSG/MIG unit might be displaced for manufacturing reasons. This displacement can be compensated for in LG/LSG, excepting LG/LSG made of tempered glass, by edge processing (e.g. polished edge). The permissible displacement tolerances (d) must be considered separately for width (B) and height (H).

2.4.1 Permissible displacement (d)

- for LG and LSG as per DIN EN ISO 12543-5:2011-12
- for MIG as per DIN EN 1279-1:2018-10

Description of glass	Displacement						
	(B, H) ≤ 1000	(B, H) ≤ 2000	2000 < (B, H) ≤ 3500	(B, H) ≤ 4000	(B, H) > 4000	3500 < (B, H) ≤ 5000	(B, H) > 5000
LG, LSG	≤ 2.0 mm	≤ 3.0 mm		≤ 4.0 mm	≤ 6.0 mm		
MIG							
All sheets ≤ 6 mm		≤ 2.0 mm	≤ 3.0 mm			≤ 4.0 mm	≤ 5.0 mm
6 mm < thickest sheet ≤ 12 mm			≤ 3.0 mm			≤ 4.0 mm	≤ 5.0 mm
One sheet > 12 mm							≤ 5.0 mm

Displacement must be within the permissible deviation limits for width and height. Width and height must be considered separately. Special dimensions and tolerances can be agreed.

Illustration of displacement in LG, LSG

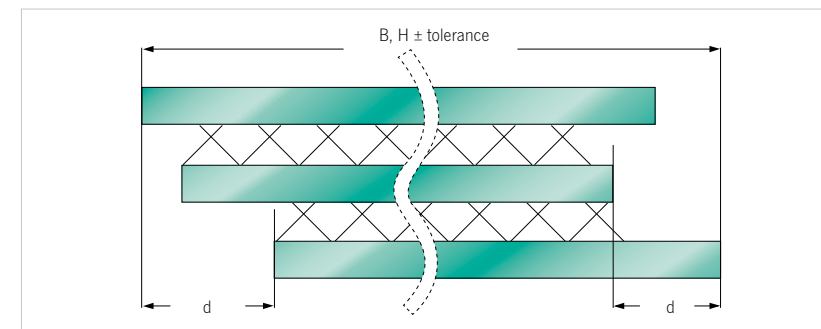
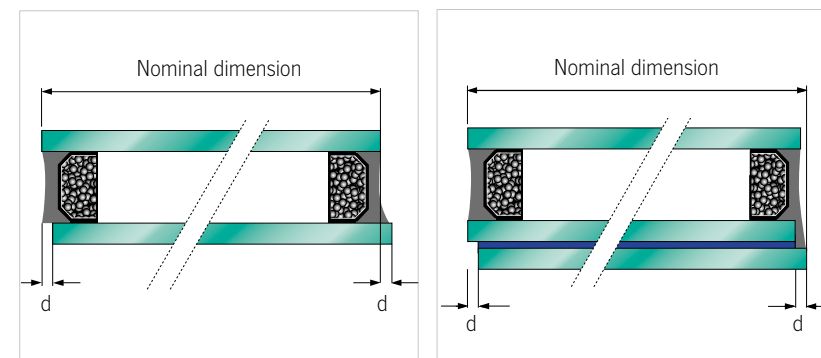

Illustration of displacement in double insulating glass and laminated safety glass, rectangles



2.5 Flatness and warping in toughened safety glass

Due to the thermal tempering process, it is not possible to manufacture a product with the same flatness of the starting material. The divergence from flatness depends on the thickness, the dimensions and the side ratio. The fault can manifest itself in the form of warping. There are two types of warping:

- General warping
- Local warping (roller waves)

Warping is generally unavailable and does not constitute grounds for complaint. If the direction of warping affects the use of the glass, this must be discussed in advance (e.g. doors in all-glass systems with warping differing from that in adjacent glass components).

General warping (t_G)

- The glass sheet is placed vertically onto two blocks on its long side at room temperature.
- The blocks are one quarter of the edge length away from the corner.
- The warp is determined using a taut wire/straight edge as the maximum distance D from the concave surface of the glass sheet. It is measured along the glass edges and the diagonals.
- The general warp is expressed as the ratio of the warp D to the edge length B or H .

$$t_G = \frac{D}{B \text{ or } H \text{ or diagonal}} \frac{\text{mm}}{\text{m}}$$

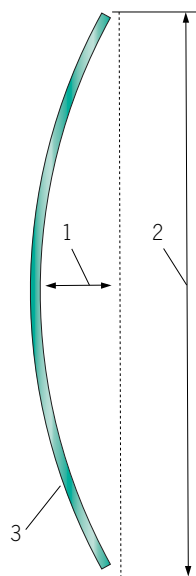

- 1 Deflection (D) for calculating the general warp t_G
- 2 B or H , or the diagonal
- 3 Heat-strengthened glass

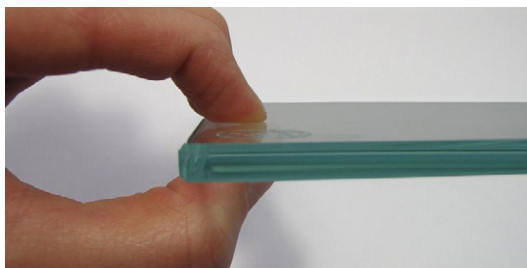
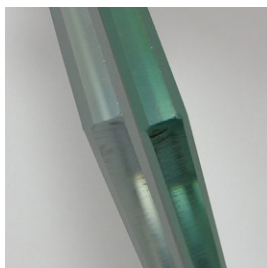

Local warping t_W (roller waves)

The local warp is measured over a distance of 300 mm using a taut wire/straight edge. It is expressed as the ratio of the spacing to 300 mm length:

the measurement must be performed at a distance of at least 25 mm to the edge.

With ornamental glass, the local warp is determined using a straight edge on the textured side, by placing it on the highest points of the texture and measuring it relative to the lowest point of the texture.

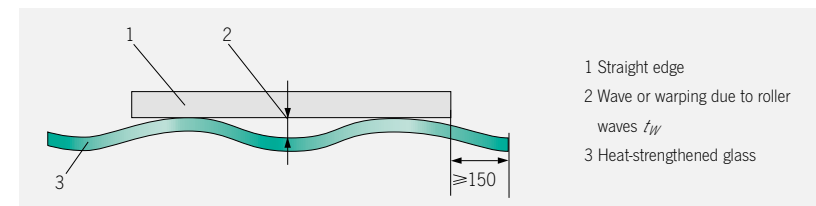

- 1 Straight edge
- 2 Wave or warping due to roller waves t_W
- 3 Heat-strengthened glass

Warping due to unevenness of the edges

The glass must be laid on a flat support, with the unevenness of the glass edge protruding 50 to 100 mm beyond the edge of the support. The straight edge must be placed on the apex points of the roller waves, and the

gap between the straight edge and the glass measured using a feeler gauge. The permissible tolerances for the flatness of the edges t_K are given in the table.

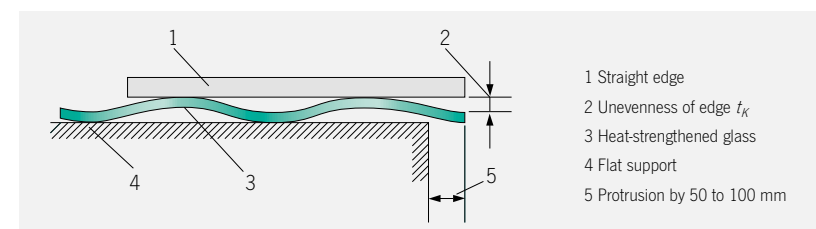

- 1 Straight edge
- 2 Unevenness of edge t_K
- 3 Heat-strengthened glass
- 4 Flat support
- 5 Protrusion by 50 to 100 mm

Flatness and warping

	Float glass uncoated	Other*
General warping	3.0 mm/m	4.0 mm/m
Local warping	0.3 mm/300 mm	0.5 mm/300 mm
Unevenness of edges		
Glass thickness 3 mm	0.5 mm	0.5 mm
Glass thickness 4-5 mm	0.4 mm	0.5 mm
Glass thickness > 5 mm	0.3 mm	0.5 mm

* The appropriate manufacturer must be consulted about tolerances for enamelled glass. This also applies for coated glass (hardenable layer).

PROCESSING

3.1 Edges

The cut edge is as a rule bevelled, and in particular with thicker sheets and non-straight shaped sheets irregular breakage points can also occur, e.g. due to application of the cutting tool. In addition, processing areas can result (e.g. by fracturing of the glass using breaking pliers).

Edge processing as per DIN 1249-11:2017-05

Depending on requirements, various edge processes are used. The tolerances depend on the respective type of edge processing.

Edge description	Arriss	Edges (area at end face)
Cut edge	No processing	Cut edge
Edge arrissed	Bevelled, shelling	Cut surface visible
Edges ground	Matt without shelling, approx. 1-2 mm	Matt without shelling, cut surface not visible
Edge polished	Sheen without shelling, approx. 1-2 mm	Sheen without shelling, cut surface not visible

Polished and ground edges come in various geometric types:

Mitred, C-finish, round edge or stepped finish. In glass processing, the term "adjustment" is used instead of "precision-ground" and also "fine adjustment" for "ground".



Note: The SANCO Tolerance Manual is based on the currently valid DIN / EN standards and on recognised guidelines. If there have been any changes since going to print, they shall take precedence.

Cut edge (KG)

The cut edge is obtained by scoring and then breaking the glass along the cut. The cut edges are sharp. In the cut edge, the Wallner lines are visible transversely to the rims.

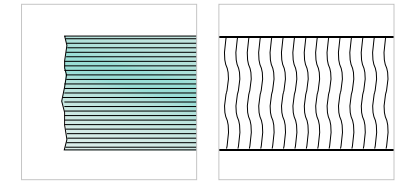

Arrissed edge (KGS)

The arrissed edge corresponds to a cut edge whose borders are more or less bevelled. Tolerances for over/underbreak are permissible as described on page 8.

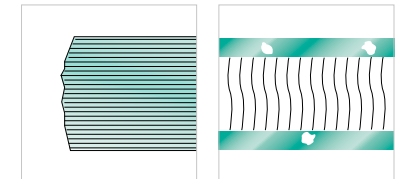

Precision-ground edge (KMG)

The glass sheet is worked to the required dimension by grinding the edge surface. Bare spots and shelling are permitted.

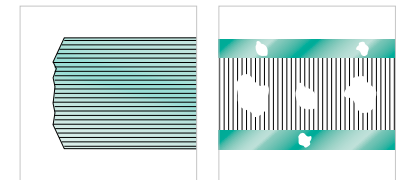

Ground edge (KGN)

The edge surface is fully worked by grinding. The ground edge has a frosted appearance. Bare spots and shelling are not permitted.

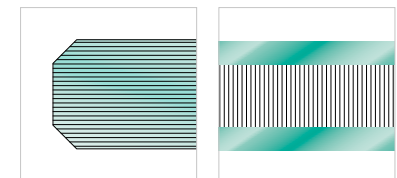

Polished edge (KPO)

The polished edge is a ground edge improved by polishing. Polishing traces are permissible to a certain extent.



Mitre edge

For design reasons, the mitre edge forms an angle of $\alpha < 90^\circ$ e. g. $\alpha = 45^\circ$ to the glass surface.
The edges can be ground or polished.

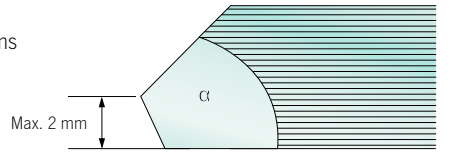

Facet edge (FK)

With most of the edge surface, the facet edge forms an angle deviating from 90° to the glass surface. Depending on the facet width, a distinction is made between flat and steep facets. For manufacturing reasons, the faceted edge runs towards a residual edge (chamfer) positioned vertically to the glass surface. The residual edge can be cut, ground or polished and has either a straight, half-round or flat-round shape.

The tolerances depend on the respective type of edge processing. The edge processing qualities also apply for TSG, heat-soaked TSG, HSG, LG and LSG made from TSG or HSG. Glass is generally at least arrissed (KGS) for process technology reasons before every tempering process.

Tolerance of the arriss for precision-ground, ground and polished edges

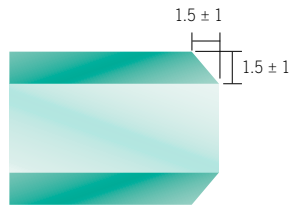

3.2 Corner cut-outs / edge cut-outs / surface cut-outs

- Edge cut-outs and corner cut-outs must be provided with a radius (R). Minimum radii must be clarified with the manufacturer in question.
- Cut-out sizes must be dimensioned such that distance tolerances can be equalised. See following table.

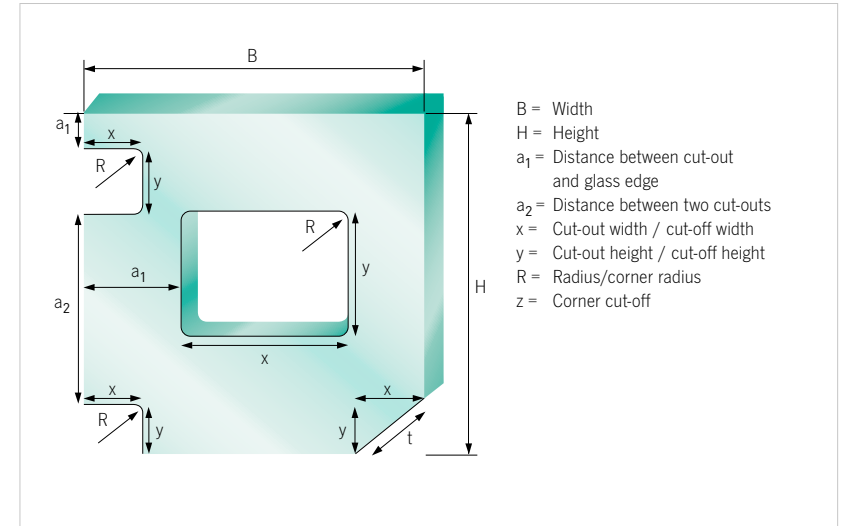

Tolerances for cut-outs and speakthroughs

These tolerances are dependent on the respective technical factors. Clarification in advance with the SANCO company.

Edge cut-out, corner cut-out, corner cut-off, surface cut-out – tolerances

	Glass thickness	Tolerances (a_1, a_2, x, y)	
		Manual processing	CNC processing
Edge cut-out / corner cut-out arrissed	≤ 8 mm	3 mm	1.5 mm
	> 8 mm	4 mm	1.5 mm
Edge cut-out / corner cut-out ground / polished	≤ 8 mm	on request	1.5 mm
	> 8 mm	on request	on request
Corner cut-off arrissed / ground / polished	≤ 8 mm	3 mm	1.5 mm
	> 8 mm	5 mm	1.5 mm
Surface cut-out arrissed / ground / polished	≤ 8 mm	3 mm	1.5 mm
	> 8 mm	5 mm	1.5 mm

3.3 Holes

Additional tolerances for the positions of holes relative to the sheet edge and between the holes

Nominal thickness	Deviation limit (<i>t</i>) of nominal dimensions in mm		
	(B, H) ≤ 2000	(B, H) ≤ 3000	(B, H) > 3000
≤ 8 mm	± 2.0 mm	± 3.0 mm	± 4.0 mm
> 8 mm	± 3.0 mm	± 4.0 mm	± 5.0 mm

Permissible tolerance of hole diameters for TSG as per DIN EN 12150-1:2015-12

Nominal diameter of hole	Permissible tolerance
4 - 20 mm	± 1.0 mm
≤ 100 mm	± 2.0 mm
> 100 mm	Depending on manufacturer

Counterbore in consultation with the manufacturer Hole tolerances apply on the basis of the above EN standard also for heat-soaked TSG, HSG and thermally non-pretreated glass types.

Hole tolerances

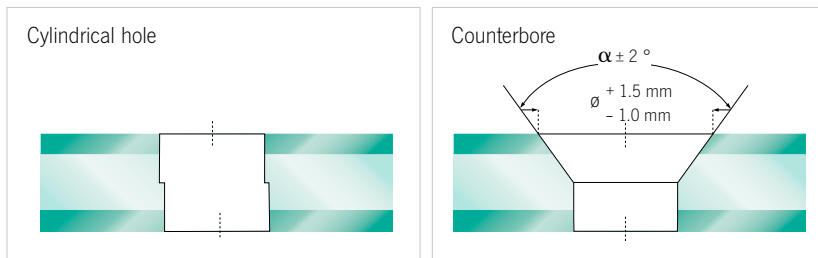

The tolerances apply for cylindrical holes and counterbores.
For undercut systems, tolerances must be enquired for the individual case.

It should be noted that the tolerances from the displacement in LG/LSG must also be taken into account for hole drilling. See Chapter 2.4.1.

The hole diameter

The hole diameter should, due to the required intermediate layer for padding fastening means contacting the glass edge, be at least 4 mm larger than the diameter of the fastener, unless requirements resulting from the design necessitate different dimensions for the intermediate layers.

LSG with stepped edges

For LSG with stepped edges, protruding film in the area of the edge is removed. Protrusions are however never fully avoidable and so do not constitute grounds for complaint.

Processing

- For LSG elements made of two or more glass types, the edges of the individual sheets can be made as KG, KGS, KMG, KGN or KPO according to DIN 1249-11:2017-05. Also, the entire package can be processed at the glass edge. In the case of TSG or HSG glass, no subsequent processing (e.g. edges, holes) is possible. Protruding film and visible groove between the individual sheets are possible. For combinations of non toughened glass, subsequent processing is permissible.
- In LSG combinations of TSG, heat-soaked TSG or HSG glass, both glass types are as a rule provided with an appropriate stamp.



GUIDELINE FOR ASSESSMENT OF THE VISUAL QUALITY OF GLASS FOR THE CONSTRUCTION INDUSTRY

4.1 This chapter contains the requirements for "assessment of the visual quality of glass for the construction industry" as per DIN EN 1279-1:2018-10, Annex F and G.

Introduction

Glass products in the construction industry are made and processed for a wide range of applications. Generally speaking, a distinction can be made between single glass types (a monolithic sheet or at least two sheets joined together as a laminate) and multi-pane insulating glass types as a combination of several single sheets with cavities, for which the various specific technical rules apply. Depending on the product properties, these glass types must undergo various production steps. Each production step can affect the visual quality of the glass. During the actual manufacture of the single glass type, unavoidable optical flaws occur that can only be reduced by visual checking and then separating flawed parts. This also applies to all the following processing# steps. Requirements going beyond this standard quality must be agreed upon separately.

4.1.1 Range of applicability

Assessment is performed out in accordance with the testing principles described below with the aid of the tolerances specified in the tables.

Assessment is of the remaining clear glass area in the installed state. Glass products designed with coated glass, with through-coloured glass, laminated glass or tempered glass (toughened safety glass, heat strengthened glass) can also be assessed with the help of the tables.

Switchable/dimmable glass and glass with installed and movable devices must be assessed in the transparent/bright state. The standard does not only apply for glass in special designs and structures, e.g. glass products using ornamental glass, wired glass, special safety glass (LSG and LG with more than two sheets), fire protection glass and non-transparent glass products.



These glass products must be assessed on the basis of the materials used, the production processes and the corresponding information from the manufacturer. Installed elements inside the cavity or in the lamination are not assessed.

4.1.2 Inspection

In inspection, it is the transparency of the glazing, i.e. the view of the background, and not the view onto the surface, which is generally regarded as the key criterion. The defects must not be specially marked.

Inspection of glazing according to the tables must be carried out at a distance of at least 3 m from the inside to the outside, for a duration of up to 1 minute per m² and at a viewing angle that corresponds to the general use of the room. Inspection is conducted preferably under conditions of diffuse daylight (such as overcast sky) without direct sunlight or artificial light. These conditions must be simulated for the assessment during the production process.

The glazing inside rooms (interior glazing) should be tested under normal (diffuse) illumination intended for room utilisation, at a viewing angle which is if possible perpendicular to the surface. Changes to the lighting in rooms, e.g. by the installation of new light fixtures, can alter the visual impression of the glass types.

Possible assessment from the outside to the inside is carried out in the installed condition at conventional viewing distances. Inspection conditions and viewing distances as regulated in product standards for the glass products under consideration may diverge from conventional conditions. The test conditions described in these product standards often cannot be complied with at the actual structure.

All divergences from the standard DIN EN 1279-1:2018-10, Annex F and G, must be agreed upon individually.





4.2 Tolerances for visual quality of glass products for the construction industry

4.2.1 Zones for assessment of visual quality

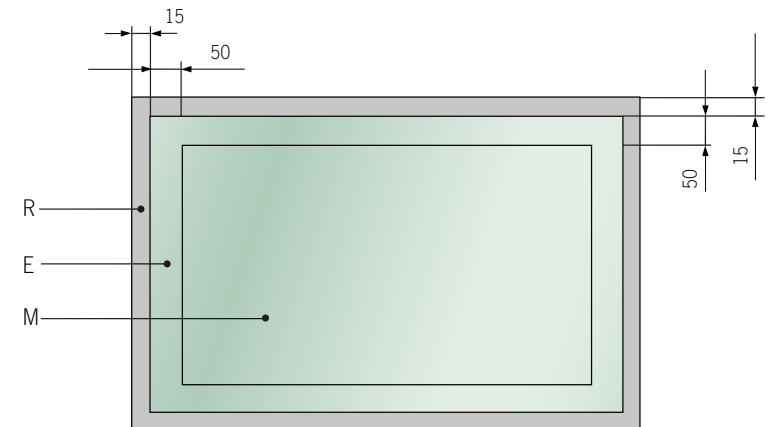

R = Rabbit zone

Area of 15 mm normally covered by the frame (with the exception of mechanical edge damage, no restrictions). For free glass edges, the viewing criterion for the rabbit zone (see above) does not apply.

E = Edge zone

Area at edge of visible surface, with a width of 50 mm.
For glass edges of < 500 mm, 1/10 of the glass edge lengths must be assumed as the edge zone.

M = Main zone

The remaining area

4.2.2 Permissible number of punctiform features in MIG as per DIN EN 1279-1:2018-10

Zone	Size of features (w/o corona, dia. in mm)	Sheet size S (m ²)			
		S ≤ 1	1 < S ≤ 2	2 < S ≤ 3	3 < S
R	All sizes	Without restrictions			
E	Dia. ≤ 1	Permissible if less than 3 in every area with dia. ≤ 20 cm			
	1 < dia. ≤ 3	4	1 per meter of edge length		
	Dia. > 3	Not permissible			
M	Dia. ≤ 1	Permissible if less than 3 in every area with dia. ≤ 20 cm			
	1 < dia. ≤ 2	2	3	5	5 + 2/m ²
	Dia. > 2	Not permissible			

Note: Existing field defects (corona) may not be larger than 3 mm

4.2.3 Permissible number of punctiform and stain-like residues in MIG as per DIN EN 1279-1:2018-10

Zone	Size and type (dia. in mm)	Sheet size S (m ²)	
		S ≤ 1	1 < S
R	All	Without restrictions	
E	Punctiform dia. ≤ 1	Without restrictions	
	Punctiform 1 mm < dia. ≤ 3	4	1 per meter of edge length
	Stain dia. ≤ 17	1	
	Punctiform dia. > 3 and stain dia. > 17	Not more than 1	
M	Punctiform dia. ≤ 1	Not more than 3 in every area with dia. ≤ 20 cm	
	Punctiform 1 < dia. ≤ 3	Not more than 2 in every area with dia. ≤ 20 cm	
	Punctiform dia. > 3 and stain dia. > 17	Not permissible	

4.2.4 Permissible number of linear/elongated features (e.g. scratches) in MIG as per DIN EN 1279-1:2018-10

Zone	Individual lengths (mm)	Individual lengths in total (mm)
R	Without restrictions	
E	≤ 30	≤ 90
M	≤ 15	≤ 45

4.2.5 Permissible punctiform features in the visible area of LSG as per DIN EN ISO 12543-6:2012-09

Defect size Dia. (mm)		0.5 < dia. ≤ 1.0	1.0 < dia. ≤ 3.0			
			A ≤ 1	1 < A ≤ 2	2 < A ≤ 8	A > 8
Sheet size A (m ²)		All sizes				
Number or density of permissible defects	2 sheets	No restrictions, but no accumulation of defects	1	2	1/m ²	1.2/m ²
	3 sheets		2	3	1.5/m ²	1.8/m ²
	4 sheets		3	4	2/m ²	2.4/m ²
	≥ 5 sheets		4	5	2.5/m ²	3/m ²

Note: When four or more defects occur in a distance from each other of < 200 mm, this is referred to as accumulation. With three-sheet laminated glass, this distance is decreased to 180 mm, with four-sheet laminated glass to 150 mm and with laminated glass with five or more sheets to 100 mm.

The number of permissible defects in the table must be increased by one for every single intermediate layer thicker than 2 mm.

4.2.6 Permissible linear features in the visible area of LSG as per DIN EN ISO 12543-6:2012-09

Sheet size (m ²)	Number of permissible features with > 30 mm length*
≤ 5	Not permissible
5 - 8	1
> 8	2

*Linear defects of less than 30 mm in length are permitted.

4.2.7 LSG films

The colour impression can in the case of clear, matt and colour films be altered by the effects of radiation over time. This can, in the case of replacement glass, lead to colour differences becoming visible, which are however permissible. Furthermore, colour differences can arise between one production batch and another.

4.2.8 Delaminations

Any construction with unprotected and non-surrounded edges can, in the case of LSG sheets, result in some cases result in visual impairments (including clouding and blistering) due to penetration over time of moisture into the PVB intermediate film via the glass edge. This can also occur due to high humidity in combination with high temperatures and increased salinity (e.g. in coastal areas). These phenomena do not necessarily have to be classed as safety-relevant or lead to consequences endangering the structural stability of linear-supported LSG sheets, nevertheless we generally advise against LSG edges in vertical and horizontal LSG applications being freely exposed to weather effects. When edges are affixed and covered, it must be assured that the materials of the adhesive and the LSG film are compatible. Delaminations (e.g. clouding and blistering) do not constitute grounds for complaint.

4.2.9 Tolerances for triple insulating glass, laminated glass (LG) and laminated safety glass (LSG):

The tolerances for Zones E and M in the tables 4.2.2, 4.2.3 and 4.2.4 increase in frequency for each additional glass unit and for each laminated glass unit by 25 % of the values specified above. The result is always rounded up. Example: a triple insulating glass unit with 2 x LSG leads to an increase in the permissible features of $3 \times 25 = 75$ %.

4.2.10 Tolerances for monolithic single glass types

The tolerances for Zones E and M in the tables 4.2.2, 4.2.3 and 4.2.4 decrease in frequency by 25 % of the values specified above. The result is always rounded up.

4.2.11 Additional requirements for thermally treated glass types

For toughened safety glass (TSG) and heat-strengthened glass (HSG) plus laminated glass (LG) and laminated safety glass (LSG) made of TSG and/or HSG, the following applies:

Local waviness on the glass surface – except in TSG of ornamental glass and HSG of ornamental glass – may not exceed 0.3 mm relative to a measurement distance of 300 mm. The warping relative to the entire glass edge length – except in TSG of ornamental glass and HSG of ornamental glass – must be no greater than 3 mm per 1000 mm of glass edge length. For square formats and approximately square formats (up to 1:1.5) and for individual sheets with a nominal thickness of < 6 mm greater distortions can occur.

For bonded glass structures, higher requirements apply as a rule so that the requirements in the approval relating to the geometry of the adhesive joint can be met.

4.3 Spacers

Rigid hollow-section spacers and flexible spacers are used. In the case of the rigid hollow-section spacers, the corner can be designed curved, welded or inserted.

Depending on the manufacturing process, gas-filling holes may be visible in the spacer element. Visible saw cuts or sealing points at the joints of the spacers are also permissible. Differences in appearance are present depending on the spacer type, coloration and corner design. An identification on the spacer section is permissible as per DIN EN 1279-1:2018-10.

Permissible production-related features in the edge connection:

- joints of the common spacer systems
Asymmetrical distribution, burring, fissuring ≤ 1 mm
- Small quantity of leaked desiccant
- Indents, impressions, dust
- Holes for gas filling and pressure equalisation

Tolerances of spacer straightness

With double glazing, the tolerance for the straightness of the spacer is 4 mm up to an edge length of 3.5 m and 6 mm for longer edges. The permissible divergence of the spacer element(s) in relation to the

parallel straight glass edge or to other spacer elements (e.g. in triple glazing) is 3 mm up to an edge length of 2.5 m. For longer edges the permissible divergence is 6 mm.

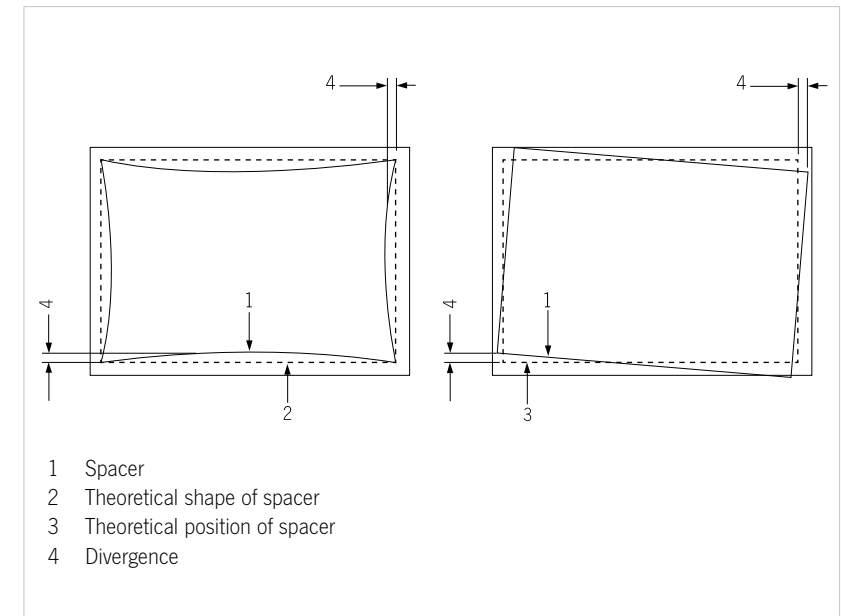

4.4 Visual properties of glass products

4.4.1 Natural colour

All materials used for glass products have natural colours due to their raw materials; these natural colours may become more apparent as the glass thickness is increased. Coated glass is used for functional reasons. Coated glass too has a natural colour. This natural colour may be more or less apparent when looking through and/or looking on the glass. Variations in the colour impression may be possible and cannot be prevented due to the content of iron oxide in the glass, the coating process, the coating itself and due to changes in the glass thicknesses and the glass structure.

4.4.2 Colour differences in coatings

For an objective assessment of the colour differences in coatings, measurement and/or inspection of the colour differences under previously well-defined conditions (glass type, colour, light source) is required. An assessment of this type cannot be taken from ISO 11479-2:2011-10 for visual assessment.

4.4.3 Removal of edge coating

Depending on the coating system ("low E coatings"), the coating is as a rule largely removed by grinding in the edge connection area of an insulating glass unit. This may make processing marks visible, so that this glass surface differs from the area that is still coated. The same holds true for the projecting glass in stepped edge insulated glass. Due to the contact of sealant and coating, the result may be a visually discernible so-called "colour line". Depending on the coating type, it may be visible as a red, green, blue line etc. The result may also be a so-called "white line", i.e. a clear stripe which is not coated is discernible between the coating and the primary

sealant. These effects are visible when the insulating glass is installed with little or no edge connection coverage.

4.4.4 Damage to outer surfaces

Mechanical or chemical outer surface damage of which the cause can generally be determined are an apparent defect. This glass must be detected by the incoming goods inspection. Further processing is not permissible. If this glass is processed after all, there can be no claim to transfer the follow-up costs.

4.4.5 Physical features

For a number of unavoidable and hence permissible phenomena that may occur in the visible area of the glass, there are no criteria for assessment defined in DIN EN 1279-1:2018-10.

They include:

- Interference phenomena
- Insulating glass effect
- Anisotropies
- Condensation on the outer surfaces of the sheets
- Wettability of glass surfaces

4.5 Explanations of terms

4.5.1 Interference phenomena

In insulating glass made from float glass, interference in the form of spectral colours can occur. Optical interference is superpositioning of two or more light waves that converge at one point. It is manifested by more or less intense coloured zones which change when pressure is applied to the sheet. This physical effect is enhanced by the plane-parallelism of the glass surfaces. This plane-parallelism ensures a distortion-free view through the glass. Interference phenomena occur randomly and cannot be influenced.

4.5.2 Insulating glass effect

Insulating glass has an air/gas volume trapped by the edge connection and the state of which is determined substantially by the barometric air pressure, the altitude of the production facility above sea level (ASL) and by the air temperature at the time and place of manufacture. Installing insulating glass at other altitudes, with temperature variations and fluctuations in the barometric air pressure (high and low pressure), necessarily induces concave or convex bulging of the individual sheets and thus optical distortions. Multiple reflections of varying intensity can also occur on glass surfaces. These reflections can be discerned more intensely if for example the background to the glazing is dark. This phenomenon is a law of physics.

4.5.3 Anisotropies

Anisotropies are a physical effect in heat-treated glass types, resulting from the internal stress distribution. The perception of dark-coloured rings or stripes depending on the angle of vision when the light is polarised and/or when viewing through polarising glass types is possible.

Polarised light is present in normal daylight. The extent of polarisation is dependent on the weather and the solar altitude. The double refraction is more easily discernible with a flat angle of vision or when glass surfaces are at an angle to one another.

4.5.4 Condensation on outer surfaces of sheets

Condensate can form on the outer surfaces of the glass when the glass surface is colder than the surrounding air (e.g. misted-up car windows). Condensation on the outer surfaces of a glass sheet is determined by the U_g value, the humidity, the air flow and the inner and outer temperatures.

Condensation on the room-side sheet surface is promoted when air circulation is hindered, e.g. by deep reveals, curtains, plant pots, flower boxes, blinds and also by unfavourable arrangement of radiators, lack of ventilation etc.

In the case of insulating glass with high thermal insulation, condensation can temporarily form on the glass surface on the weather side if the outside humidity (relative humidity outdoors) is high and the air temperature is higher than the temperature of the sheet surface.

A dew point calculator can be found at www.sanco.de

4.5.5 Wettability of glass surfaces

The wettability of glass surfaces can vary, e.g. due to imprints from rollers, fingers, labels, paper residue, vacuum suction pads, sealant residues, smoothing agents, lubricants or environmental effects. In the case of moist glass surfaces due to condensate, rain or cleaning water, the differing wettability can become visible.

4.6 Permissible visible features for polished wired glass as per DIN EN 572-8:2012+A1:2016

Type of feature	Size	Position relative to the wire	
		In contact with wire or ≤ 2 mm away from it	> 2 mm away from wire
Spherical and quasi-spherical	≤ 1 mm		Permissible
	≤ 2 mm	Permissible	
	> 1, ≤ 4 mm		Max. 0.5 pc./m ² of sheet area permissible
	> 2, ≤ 4 mm	Max. 0.5 pc./m ² of sheet area permissible	
	> 4 mm	Not permissible	Not permissible
Elongated, punctiform	≤ 1 mm x ≤ 1 mm	Permissible	
	≤ 1 mm x ≤ 5 mm	Max. 8 pc./m ² of sheet area permissible	
	≤ 1 mm x ≤ 15 mm	Max. 2 pc./m ² of sheet area permissible	
	≤ 1 mm x ≤ 15 mm	Not permissible	
	≤ 1 mm x ≤ 4 mm	Max. 0.5 pc./m ² of sheet area permissible	
	≤ 1 mm x ≤ 4 mm	Not permissible	
Design	Divergences in design max. 12 mm per metre		
Wire mesh	Divergences in wire mesh max. 15 mm per metre		
	The deformation of the wire in individual meshes is not taken into account.		
	Wires protruding from the glass surface are not permissible		

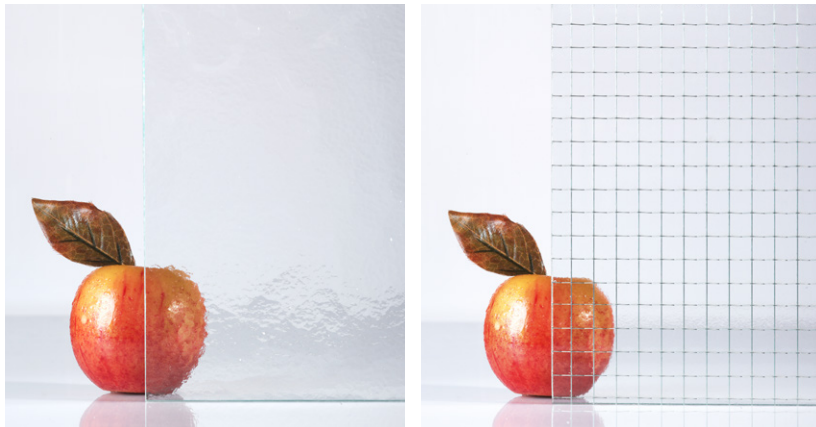

4.7 Permissible visible features for ornamental and wired ornamental glass as per DIN EN 572-8:2012+A1:2016

Type of feature	Size	
Spherical and quasi-spherical	≤ 2 mm	Permissible
	≤ 5 mm	Max. 2 pc./m ² of sheet area permissible
	> 5 mm	Not permissible
Elongated, punctiform	≤ 2 mm x ≤ 4 mm	Permissible
	≤ 2 mm x ≤ 25 mm	Permissible if sum of lengths is ≤ 80 mm per m ² of sheet area
	≤ 2 mm x ≤ 25 mm	Not permissible
	≤ 2 mm x ≤ 8 mm	Max. 2 pc./m ² of sheet area permissible
	≤ 2 mm x ≤ 8 mm	Not permissible
	Design	Divergences in design max. 12 mm per metre
Wire mesh	Divergences in wire mesh max. 15 mm per metre	
	The deformation of the wire in individual meshes is not taken into account.	
	Wires protruding from the glass surface are not permissible	

Divergences in design

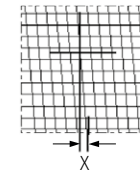

Non-rectangularity

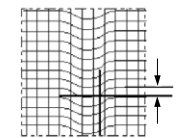

Waviness

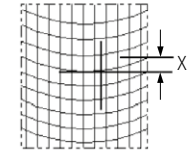

Arching

Divergences in wire mesh

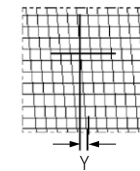

Non-rectangularity

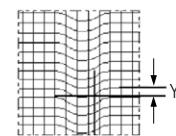

Waviness

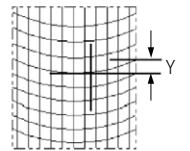

Arching



ASSESSMENT OF SASH BARS INSIDE THE CAVITY

5.1 Assessment of sash bars inside the cavity

This chapter contains the BF Technical Guide 016/2013 for assessment of sash bars inside the cavity. This guideline was written and published by Bundesverband Flachglas e. V., Troisdorf, dated 2013

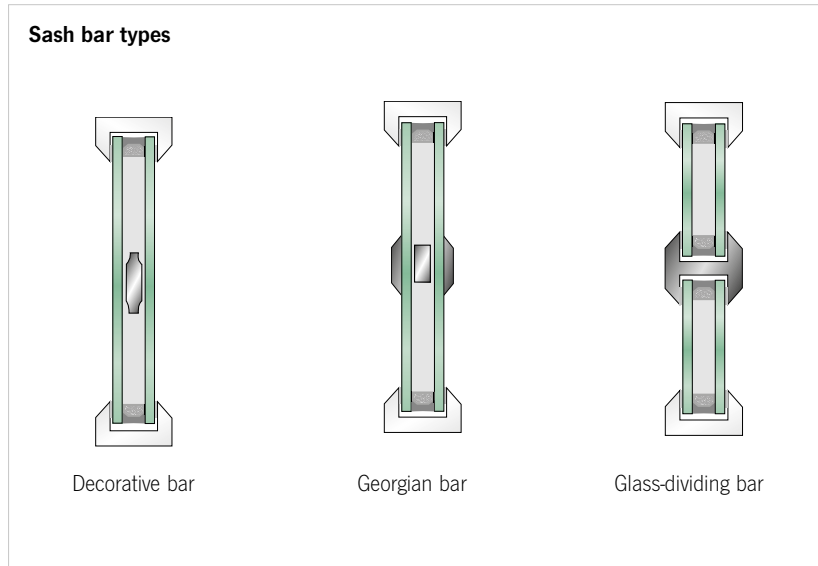

5.2 Criteria for assessment

Generally speaking, a viewing angle of 90 ° must be assumed, corresponding to the usual use of the room. Viewing is generally at a distance of more than 2.0 m. The defects may not be marked, and no direct sunlight or artificial light may act on the bars.

Testing is conducted under conditions of diffuse daylight (such as overcast sky) without direct sunlight or artificial light. The glazing inside rooms (interior glazing) should be tested under normal (diffuse) illumination intended for room utilisation, at a viewing angle preferably perpendicular to the surface.

The assessment must be conducted with unimpaired transparency onto a neutral background. The overall impression of the window is decisive.

5.3 Colour tolerances

The sash bar surfaces are manufactured to certain standards, e.g. RAL for their colour. The accuracy of the colour tone (visually assessed) depends on many parameters regulated in these standards.

Note:

Colour tone divergences over time are not dealt with by this technical guide, as they depend on the location (e.g. differing UV radiation).

- Physically related heat cracks in anodized surfaces are permissible
- Changes to the sash bar surface on the narrow sides of bars inside the cavity are permissible

The natural colour and the coating of the glass can affect the colour effect of the sash bar surface!



5.4 Design

Connections

Connections to the spacer frame are state of the art in some spacer systems and are therefore permissible.

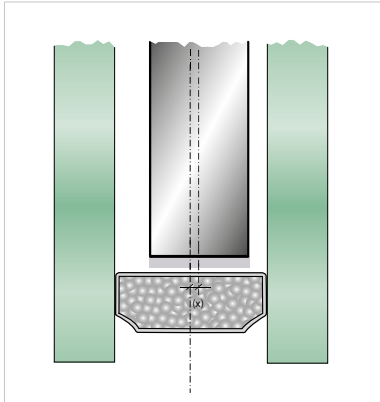

Connection of sash bar to spacer frame

Sash bar centre to spacer centre (x) max. ± 1 mm. The cavity must be considerably larger than the design height of the sash bars. Visible saw cuts are production-related. Major peeling of paint in the cutting area is not permissible.

Sash bar rattle

Where sash bars are installed in the cavity, rattling noise might occur in various circumstances due to the unavoidable contact of the bars with the glass surface. This is unavoidable and cannot be regarded as a defect. If required, rattling can be muffled, though not eliminated, by attaching felt pads or silicone studs, for example to the intersection points of the sash bars. These felt pads or studs are however excluded from warranty.

Parallelism and positional tolerance of the sash bar relative to the spacer

The permissible divergence (x) from the set position is, in the delivery state of the insulating glass, ± 2 mm per metre of sash bar length. But at least ± 1 mm regardless of the sash bar length.

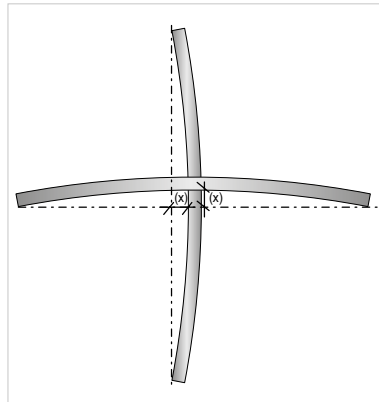

The tolerances stated must be observed without taking into account the production and installation tolerances of the insulating glass in the window, or the overall impression of the window. In triple insulating glass, it is recommended that the decorative sash bars be limited to the outer cavity.

Climate and temperature influences

The effects of temperature-related changes in the length of the sash bars inside the cavity can generally not be avoided. Production-related offset of the sash bars cannot be completely prevented. For that reason, the aforementioned tolerances are only considered at room temperature.



SCREEN PRINTING, DIGITAL PRINTING, ENAMEL

6.1 Visual quality of enamelled and printed glass

This chapter contains the BF Technical Guide 015/2013 for assessment of the visual quality of enamelled glass. This guideline was written and published by Bundesverband Flachglas e. V., Troisdorf (dated March 2014)

Range of applicability

This guideline applies to the assessment of the visual quality of fully or partially enamelled glass produced by applying and baking of ceramic paints, as toughened safety glass or as heat-strengthened glass. This guideline does not apply for coloured glass as per DIN

EN 16477-1:2017-07 or for glass with other printing methods. Building code aspects have not been covered by this guideline.

6.2 Features / tolerances for fully or partially enamelled glass

Features	Permissible tolerances
Permissible punctiform defects in the enamel*	Dia. 0.5 – 1.0 mm max. 3 pcs./m ² , with spacing ≤ 100 mm Dia. 1.0 – 2.0 mm max. 2 pcs./sheet
Hairline scratches and baked-in foreign bodies	Permissible up to 10 mm long
Clouding **	Not permissible
Water marks	Not permissible
Paint overhang at the edges	Permissible in framed sheets and for holes provided with additional mechanical brackets or covers, otherwise not. In unframed sheets with ground or polished edge: <ul style="list-style-type: none"> • In the rollercoating method, permissible on the chamfer, not permissible on the edge • Permissible in casting • Not permissible in the screen printing method • Not permissible in the digital printing method Due to the digital printing method, very small paint splashes only discernible from close up can occur in the immediate area of the print edges.
Unprinted glass rim	Screen printing and digital printing permissible up to 2 mm
Linear structures in the print	Permissible
Enamel positional tolerance (a) (see illustration)***	Sheet size ≤ 2000 mm: ± 2.0 mm Sheet size ≤ 3000 mm: ± 3.0 mm Sheet size > 3000 mm: ± 4.0 mm
Tolerance of dimensions for partial enamelling (b) (see illustration)	Edge length of printed area Tolerance range ≤ 1000 mm ± 2.0 mm ≤ 3000 mm ± 3.0 mm > 3000 mm ± 4.0 mm
Design geometry (c) (d) (see illustration)	Depending on size Edge length of printed area Tolerance range ≤ 30 mm ± 0.8 mm ≤ 100 mm ± 1.0 mm ≤ 500 mm ± 1.2 mm ≤ 1000 mm ± 2.0 mm ≤ 2000 mm ± 2.5 mm ≤ 3000 mm ± 3.0 mm > 3000 mm ± 4.0 mm
Colour deviations	The colours are assessed through the glass (enamel paint on position 2). Colour deviations in the range of $\Delta E \leq 5$ mm (float) or $\Delta \leq 4$ mm (white glass) with the same glass thickness are permissible.

*Defects of ≤ 0.5 mm ("starry sky" or "pinholes" = very small defects in the enamel) are permissible and generally not taken into account. Repairs to defects using enamel paint before the tempering process or with organic paint after the tempering process are permissible. Organic paint must not be used in the area of the edge seal in insulating glass.

**In fine decors (grid pattern with partial areas of less than 5 mm), a so-called moiré effect can occur.

For this reason, consultation with the manufacturer is necessary.

***The enamel positional tolerance is measured from the reference point, which must be agreed upon with the manufacturer.

Positional and design tolerances for the dimension in the case of printed glass

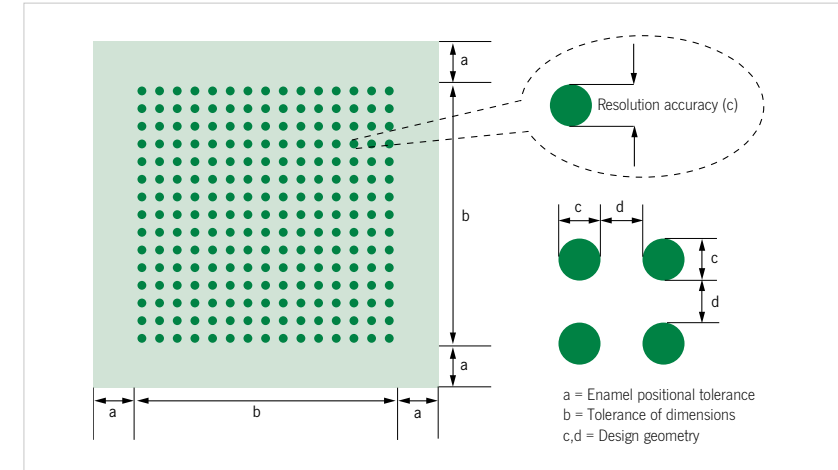

With regard to geometric figures or so-called shadow masks with a size below 3 mm or progressions from 0 – 100 %, the following remarks apply:

- If dots, lines or figures of this size are lined up at short intervals, the human eye reacts very sensitively.
- Tolerances of geometry or of the distance in the tenth of a millimetre range are noticed as gross deviations.
- In any event, these applications have to be checked regarding feasibility with the manufacturer. The production of a 1:1 pattern is recommended.

6.3 Inspection

For inspection of the visual quality of enamelled and silk-screened glass, the following requirements must be met:

Distance to glass	At least 3.0 m away
Viewing angle	As perpendicular as possible to the glass surface
Light conditions	Normal daylight without direct sunlight, without artificial light or backlight from the front or rear against a light-impermeable background
Markings	Defects must not be marked when viewing
Miscellaneous	The glass is always viewed through the untreated glass side onto the enamelled or silk-screened sheet or, in the case of glass sheets that were ordered for see-through purposes, from both sides.

With regard to TSG/HSG-specific defects, the visual guidelines for TSG apply.

Assessment zones

The assessment distinguishes between main zone and rabbet zone.

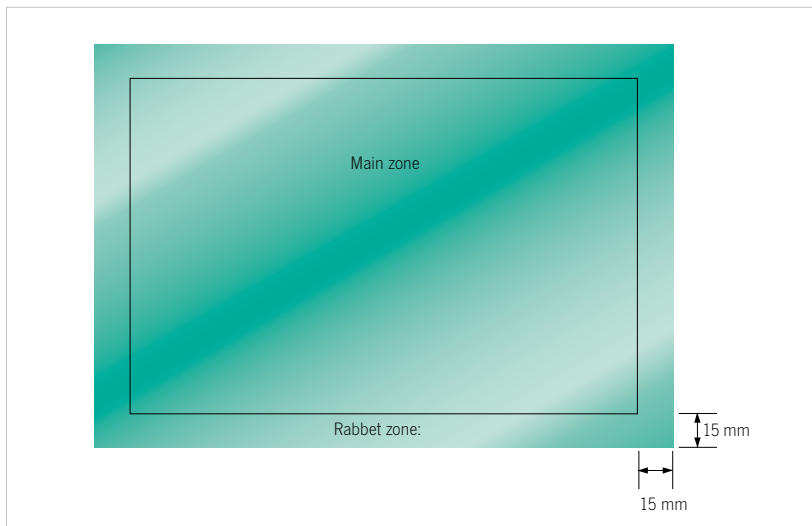

DEFINITION OF FEATURES IN AN OVERVIEW

Feature	
Deviation of the design	Deviation x of the design
Other features	Glass features such as notches and features in the intermediate layer such as folds, shrinkage and stripes.
Bubbles	Normally air bubbles that may be present in the glass or in the intermediate layer.
Folds	Impairments that are formed through folds in the intermediate layer and are visible after production.
Stains	Features in the coating which are larger punctiform features; they are often irregular in shape and sometimes have a mottled structure.
Foreign bodies	Any undesired object that has entered the laminated glass during production.
Homogeneity deviations	Any detectable deviations in colour, reflectance or transmittance within a glass sheet or from sheet to sheet.
Notches	Sharply pointed fissures or cracks that extend from an edge into the glass.
Scratches	Linear damage to the outer surface of the laminated glass. This includes a large number of linearly extended notches of which the visibility depends on their length, depth, width, position and arrangement.
Spherical or quasi-spherical punctiform defects	Punctiform features of which the larger dimension is smaller than or equal to double the smaller dimension.
Elongated, punctiform features	Punctiform features of which the larger dimension is more than double the size of the smaller dimension.
Linear features	This type of feature includes foreign bodies and scratches or grinding marks. Features that can be present in or on the glass in the form of deposits, stains or scratches having a certain length or area.
Features in design	Deviations of the design from, for example, a line or a straight edge.
Pinprick-like features	Punctiform features in the coating with partial or total absence of the coating, which generally clearly stand out against the coating when looking through.

Feature	
Clustering	Clusters of very small features that create the impression of stains.
Optical features	Features leading to distortions in the appearance of objects viewed through the glass.
Punctiform features	<p>This type of feature includes non-transparent stains, bubbles and foreign bodies.</p> <p>Punctiform faults both when looking through the glass and looking at the glass. NOTE: Soiled areas, pinprick-like features and scratches are punctiform features.</p> <p>Locally disrupted area that usually surrounds a punctiform defect when this defect is inside the glass sheet.</p> <p>Deviation x of the design</p>
Soiled areas	
Visible features	Features altering the visual quality of the glass. These are punctiform features and linear/elongated features.
Non-transparent stains	Visible features in laminated glass (for example tin stains, inclusions in the glass or in the intermediate layer.)

d	Displacement
DIN	Deutsches Institut für Normung (German Institute for Standardisation)
ΔE	Colour deviations
EN	European standard
FK	Facet edge
HSG	Heat-strengthened glass
h. s. TSG	Heat-soaked TSG
ISO	International Organisation for Standardisation
KG	Cut edge
KGN	Edges ground
KGS	Edges arrissed
KMG	Precision-ground edges
KPO	Edges polished
MIG	Multi-pane insulating glass
LG	Laminated glass
LSG	Laminated safety glass
PVB	Polyvinylbutyral
SZR	Cavity
t	Tolerance value
t_G	General warping
t_W	Local warping (roller waves)
TSG	Toughened safety glass
UV	Ultraviolet

KEYWORD INDEX

- Anisotropies 29
- Assessment of sash bars inside
the cavity 32 ff
- Assessment of visual quality 20 ff
- Colour tolerances, sash bars 33
- Colour differences, coating 28
- Condensation 29
- Corner cut-outs 17
- Cut-outs 17
- Cutback 8
- Damage to outer surfaces 28
- Delaminations 26
- Deviation limits 8
- Deviation limit tolerances 9
- Diagonal break 8
- Diagonal differences 10
- Digital printing 35 ff
- Displacement tolerance 10, 11
- Drilled holes 18, 19
- Edge coating removal 28
- Edge cut-outs 17
- Edge processing 14, 15, 16
- Enamel 35 ff
- Facet edge 16
- Flatness 12, 13
- General warping 12
- Glass thickness tolerances 6, 7
- Insulating glass effect 29
- Interference phenomena 29
- Local warping 13
- LSG with stepped edges 19
- Mitre edge 16
- Natural colour 28
- Ornamental glass 31
- Overbreak 8
- Physical features 28
- Pinholes 36
- Polished wired glass 30
- Positional tolerance, sash bars
inside cavity 34
- Roller waves 13
- Sash bars in cavity 32 ff
- Screen printing 35 ff
- Speakhroughs 17
- Surface cut-outs 17
- Thickness tolerance 6, 7
- Tolerances for visual quality 20 ff
- Underbreak 8
- Unevenness of edges 13
- Visual features in overview 39 ff
- Visual properties
of glass products 28 ff
- Visual quality, enamelled
and printed glass 35 ff
- Visual quality 20 ff
- Warping 12, 13
- Wettability 29
- Wired ornamental glass 31

SANCO®



**GLASS
CAN BE
MORE!**



Your SANCO Partner would be happy to advise you!

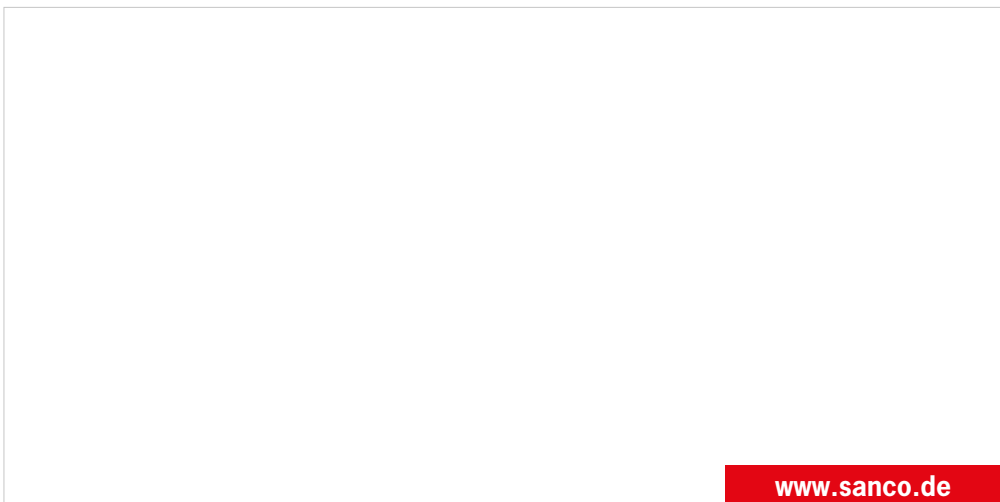

www.sanco.de